

The CRS Heavy Duty Trommel is a robust stationary screening solution with throughput capacities from 35 - 160 m³ p/Hr, efficiently sizing various materials such as C+D, MSW, FOGO, and aggregate. With customisable features, robust construction, and VSD speed control, it seamlessly integrates into recycling systems.



Features

- Heavy duty welded construction
- High density polyurethane drive wheels
- 4 No. Nord Slip on gear motor drive 5.5kw
- 4 wheel drive
- High density polyurethane retaining wheel
- SKF 75mm and 50mm bearings
- Bolt in heavy duty punch plate for easy changing (thickness & aperture to be agreed)
- Full guards with emergency stops
- Covers

Options

- Direct Hopper Feeder
- Fines bay integrated trommel supports. Robust side bay walls and rear push walls to withstand the heaviest of applications
- Brushes
- Low level feeder via incline conveyor to trommel
- Transfer fines conveyor to secondary screen

Specifications

	CRS 420	CRS 620	CRS 625	CRS 820	CRS 825	CRS 1020	CRS 1025
Width (m)	2.6	2.6	3.1	2.6	3.1	2.6	3.1
Height (m)	2.8	2.8	3.2	2.8	3.2	2.8	3.2
Length (m)	6.1	8.1	8.1	10.1	10.1	12.1	12.1
Weight (kg)	5,8000	8,250	14,200	10,800	16,200	13,000	20,000

Drum

Screen Size	12 - 120 mm						
Screen Diameter (m)	2.0	2.0	2.5	2.0	2.5	2.0	2.5
Screen Length (m)	4.0	6.0	6.0	8.0	8.0	10.0	10.0
Drum Length (m)	5.2	7.2	7.2	9.2	9.2	11.2	11.2
Discharge point (m)	0.2						

Performance

Power Supply (Kw)	22						
Motor Power (Kw)	4 x 5.5 Kw						
Motor Speed	Variable VSD						
Throughput (m ³ p/Hr)	35	70	85	100	115	140	160
Waste Types	C&D, C&I, MSW, FOGO, Aggregate						



Dimensions and technical information without obligation. Subject to change.

	Screen Length	Screen Diameter	Drum Length	Overall Width	Overall Height	Overall Length	Infeed Height	Discharge Point
MODEL	A	B	C	D	E	F	G	H
CRS 420	4.0	2.0	5.2	2.6	2.8	6.1	1.22	0.2
CRS 620	6.0	2.0	7.2	2.6	2.8	8.1	1.22	0.2
CRS 625	6.0	2.5	7.2	3.1	3.2	8.1	1.35	0.2
CRS 820	8.0	2.0	9.2	2.6	2.8	10.1	1.22	0.2
CRS 825	8.0	2.5	9.2	3.1	3.2	10.1	1.35	0.2
CRS 1020	10.0	2.0	11.2	2.6	2.8	12.1	1.22	0.2
CRS 1025	10.0	2.5	11.2	3.1	3.2	12.1	1.35	0.2

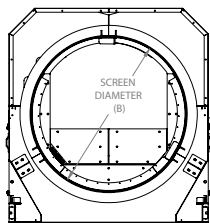
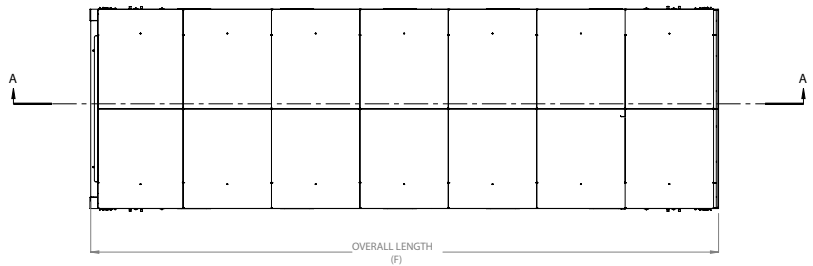
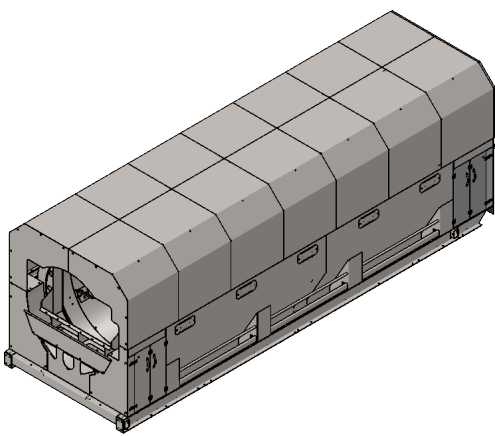

SECTION B-B

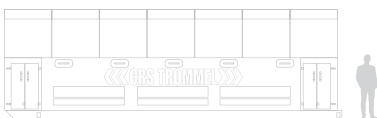
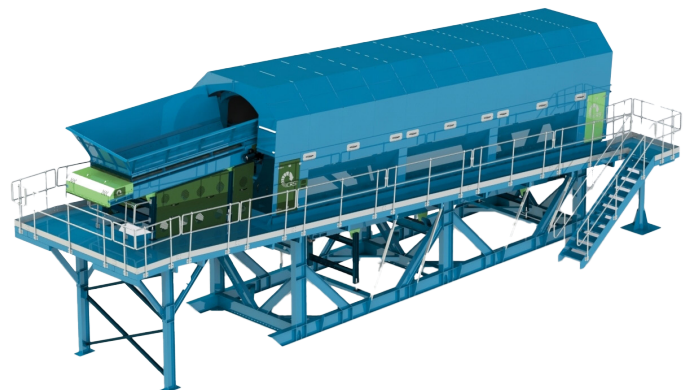
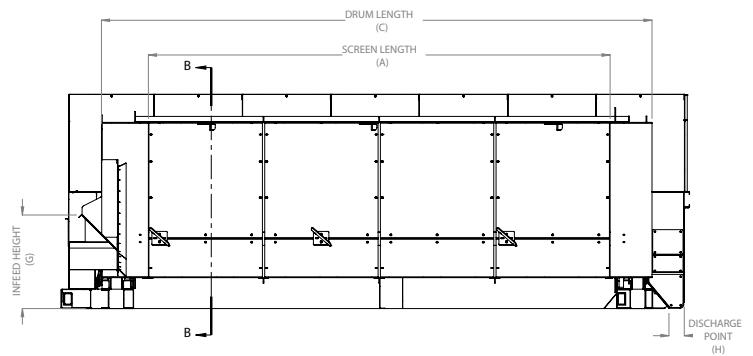
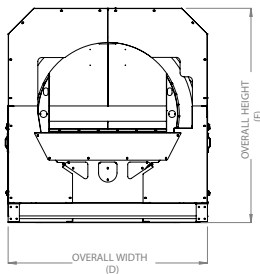

Size Comparison



Screen
12 - 120 mm



Motor
4 x 5.5 Kw



Waste Types
C+D, C+I, MSW, Soil,
Aggregate

